

---

## APP CONNECTORS

---



Anderson Power Products® (APP®), is an international leader in high power interconnect solutions. In 1877, Anderson began as a small company in Boston, MA making innovative trolley and railway power designs. Today as a subsidiary of IDEAL® Industries APP connectors are used around the world across many markets including: Telecom & IT Equipment, Motive Power, and Alternative Energy. APP offers a range of connectors to meet power, signal, & ground needs in protected or environmentally exposed applications.

---



## Powerpole

---

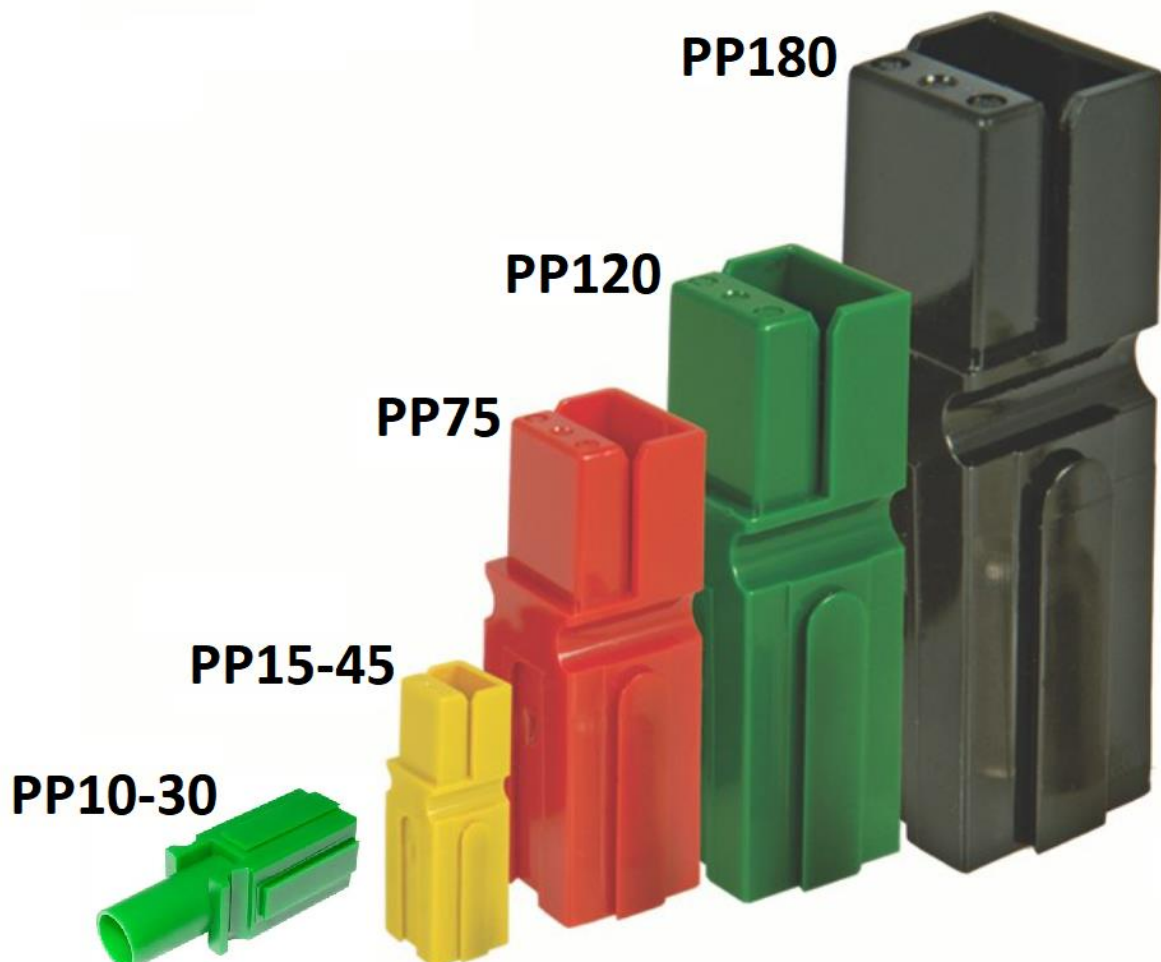
This versatile connector series invented by Anderson Power Products (APP) meets a wide range of power connection needs. The four housing sizes in the Powerpole product family can carry a wide range of amperage and wire sizes in the most compact footprint. For currents up to 350A and from wire sizes of #20 AWG (0,75 mm<sup>2</sup>) to 3/0 (70 mm<sup>2</sup>). Powerpole can handle them all! A wide range of colored housing options can be stacked together to create a proven reliable custom connector. These housings can be used with different contacts to create wire-to-wire, wire-to board, or wire-to-busbar connections. The Powerpole® connector combines high quality materials with a cost-effective and innovative design for powerful versatility.



## PP10

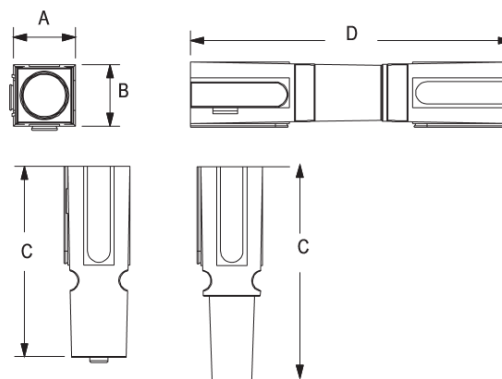

Standard housings			
Color	Ordering code	Description	
Green	1204G1-BK	Housing PP10 Female – Green	
Green	1205G1-BK	Housing PP10 Male – Green	

Series	-A-		-B-		-C-		-D-	
	mm	in.	mm	in.	mm	in.	mm	in.
PP10 Pin	7.9	0.31	7.9	0.31	24.5	0.97	41.3	1.63
PP10 Socket	7.9	0.31	7.9	0.31	27.5	1.081	41.3	1.63





 Closed Silver plated wire contacts		
Section	Ordering code	Description
14/16 AWG	1202G1	PP10 – Socket Contact – 16-14 AWG (1,31-2,08 mm <sup>2</sup> )
14/16 AWG	1203G1	PP10 – Pin Contact – 16-14 AWG (1,31-2,08 mm <sup>2</sup> )

**PP30** 

Standard housings			
Color	Ordering code	Description	
Green	PP30GND-S	Housing PP30 Female – Green	
Green	PP30GND-P	Housing PP30 Male – Green	

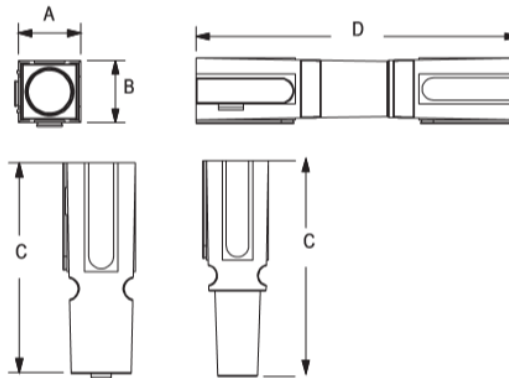
Series	-A-		-B-		-C-		-D-	
	mm	in.	mm	in.	mm	in.	mm	in.
PP30 Pin	7.9	0.32	7.9	0.32	26.6	0.97	41.2	1.62
PP30 Socket	7.9	0.32	7.9	0.32	26.6	0.97	41.2	1.62



 Closed Silver plated wire contacts		
Section	Ordering code	Description
10 AWG	1230G1	PP30 – Pin Contact – up to 10 AWG (5,26mm <sup>2</sup> )
10 AWG	1232G1	PP30 – Socket Contact – up to 10 AWG (5,26mm <sup>2</sup> )

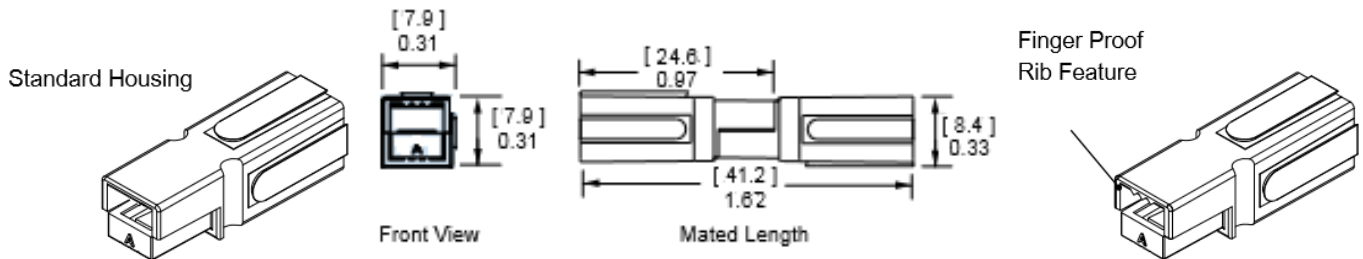

## PP15/45

Standard housings		
Color	Ordering code	Description
Red	1327-BK	Housing PP15/PP45 – Red
Green	1327G5-BK	Housing PP15/PP45 – Green
Black	1327G6-BK	Housing PP15/PP45 – Black
White	1327G7-BK	Housing PP15/PP45 – White
Blue	1327G8-BK	Housing PP15/PP45 – Blue
Yellow	1327G16-BK	Housing PP15/PP45 – Yellow
Orange	1327G17-BK	Housing PP15/PP45 – Orange
Gray	1327G18-BK	Housing PP15/PP45 – Gray
Brown	1327G21-BK	Housing PP15/PP45 – Brown
Pink	1327G22-BK	Housing PP15/PP45 – Pink
Purple	1327G23-BK	Housing PP15/PP45 – Purple

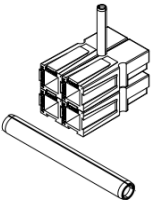
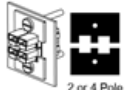
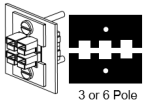
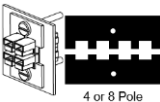
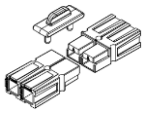
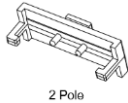
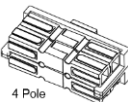
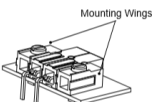

Finger proof housings		
Color	Ordering code	Description
Red	1327FP-BK	Housing PP15/PP45 “fingerproof” – Red
Green	1327G5FP-BK	Housing PP15/PP45 “fingerproof” – Green
Black	1327G6FP-BK	Housing PP15/PP45 “fingerproof” – Black
White	1327G7FP-BK	Housing PP15/PP45 “fingerproof” – White
Blue	1327G8FP-BK	Housing PP15/PP45 “fingerproof” – Blue
Yellow	1327G16FP-BK	Housing PP15/PP45 “fingerproof” – Yellow

 Closed Silver plated wire contacts		
Section	Ordering code	Description
20 to 16 AWG	1332-BK	Main Contact PP15/45 – 20-16 AWG (0,52 – 1,3 mm <sup>2</sup> )
16 to 12 AWG	1331-BK	Main Contact PP15/45 – 16-12 AWG (1,3 – 3,3 mm <sup>2</sup> )

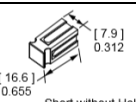
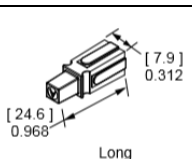
<b>Accessories</b>		
<b>Picture</b>	<b>Ordering code</b>	<b>Description</b>
	110G16 110G17	PP15/45 – Retaining Pin – 1 High PP15/45 – Retaining Pin – 2 High
	1462G1	PP15/45 – 2&4P Mounting Clamp – Set
	1462G2	PP15/45 – 3&6P Mounting Clamp – Set
	1462G3	PP15/45 – 4&8P Mounting Clamp – Set
	110G68	PP15/45 Retention Clip
	110G21	PP15/45 – 2P Block-Lok
	110G12	PP15/45 – 4P Block-Lok
	1399G9-BK 1399G8-BK	Mounting Wing for PP15/45 – <b>Red</b> Mounting Wing for PP15/45 – <b>Blue</b>
	1399G1-BK 1399G14-BK	Spacer for PP15/45 – <b>Red</b> – Short – With hole Spacer for PP15/45 – <b>White</b> – Short – With hole
	1399G6-BK 1399G13-BK	Spacer for PP15/45 – <b>Red</b> – Short – Without hole Spacer for PP15/45 – <b>Blue</b> – Short – Without hole
	1399G2-BK 1399G10-BK 1399G17-BK 1399G19-BK	Spacer for PP15/45 – <b>Red</b> – Long Spacer for PP15/45 – <b>Black</b> – Long Spacer for PP15/45 – <b>White</b> – Long Spacer for PP15/45 – <b>Grey</b> – Long

## PP75

### Standard housings

Color	Ordering code	Description
Red	5916G7-BK	Housing PP75 – Red
Green	5916G6-BK	Housing PP75 – Green
Black	5916G4-BK	Housing PP75 – Black
White	5916G5-BK	Housing PP75 – White
Blue	5916-BK	Housing PP75 – Blue
Yellow	5916G15-BK	Housing PP75 – Yellow
Orange	5916G14-BK	Housing PP75 – Orange
Gray	5916G16-BK	Housing PP75 – Gray

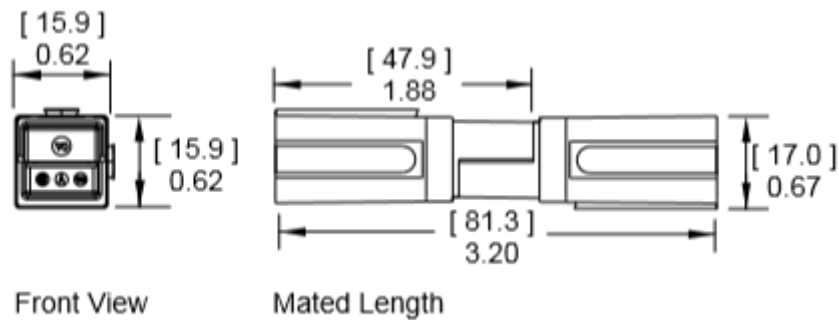

### Silver plated wire contacts

Section	Ordering code	Description
12 to 10 AWG	5915-BK	Contact PP75 – 10 AWG (5,3 mm <sup>2</sup> )
12 to 10 AWG	5953-BK	Contact PP75 – 10 AWG (5,3 mm <sup>2</sup> ) – low detent force
8 AWG	5952-BK	Contact SB50 / PP75 – 8 AWG (8,4 mm <sup>2</sup> )
6 AWG	5900-BK	Contact SB50 / PP75 – 6 AWG (13,3 mm <sup>2</sup> )
6 AWG	1307-BK	Contact SB50 / PP75 – 6 AWG (13,3 mm <sup>2</sup> ) – low detent force

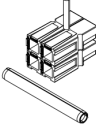
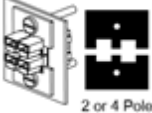
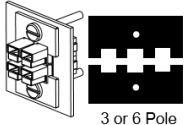
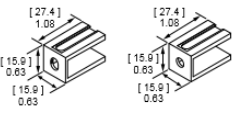
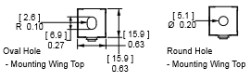
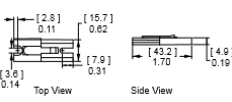
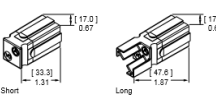
<b>Accessories</b>		
<b>Picture</b>	<b>Ordering code</b>	<b>Description</b>
	5912-BK 5910-BK 5913-BK	Reducing Bushing APP 6 AWG - 8 AWG Reducing Bushing APP 6 AWG - 12-10 AWG Reducing Bushing APP 6 AWG - 16-14 AWG
	110G19 110G18	PP75/120/180 – Retaining Pin – 1 Block High PP75 – Retaining Pin – 2 Block High
 2 or 4 Pole	1463G1	PP75 – 2&4P Mounting Clamp – Set
 3 or 6 Pole	1463G2	PP75 – 3&6P Mounting Clamp – Set
	1399G20-BK 1399G7-BK	<i>Mounting wing for Standard or CR Housings</i> Mounting Wing for PP75 – Round hole – <b>Blue</b> Mounting Wing for PP75 – Oval hole – <b>Blue</b>
 Oval Hole - Mounting Wing Top Round Hole - Mounting Wing Top	75LOKWNGBLU-BK 75LOKWNGBLU-R-BK	<i>Mounting Wing for Locking Housings</i> PL75-Wing – Oval Hole – <b>Blue</b> PL75-Wing – Round Hole – <b>Blue</b>
 Top View Side View	75LOKSMTBLU-BK	PL75-Mounting Pad – <b>Blue</b>
 Short Long	1399G23-BK 1399G21-BK	Spacer for PP75 – <b>Red</b> – Short Spacer for PP75 – <b>Red</b> – Long



## PP120

### Standard housings

Color	Ordering code	Description
Red	1321G3-BK	Housing PP120 – Red
Green	1321G4-BK	Housing PP120 – Green
Black	1321G1-BK	Housing PP120 – Black
White	1321G2-BK	Housing PP120 – White
Blue	1321-BK	Housing PP120 – Blue
Yellow	1321G7-BK	Housing PP120 – Yellow
Orange	1321G5-BK	Housing PP120 – Orange
Gray	1321G8-BK	Housing PP120 – Gray
Brown	1321G6-BK	Housing PP120 – Brown

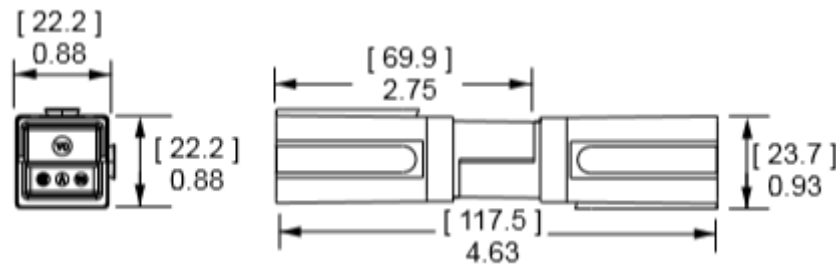

### Silver plated wire contacts

Section	Ordering code	Description
6 AWG	1319G6-BK	Main Contact SB120 / PP120 – 6 AWG (13,3 mm <sup>2</sup> )
4 AWG	1319G4-BK	Main Contact SB120 / PP120 – 4 AWG (21,2 mm <sup>2</sup> )
2 AWG	1319-BK	Main Contact SB120 / PP120 – 2 AWG (33,6 mm <sup>2</sup> )
1 AWG	1323G1-BK	Main Contact SB120 / PP120 – 1 AWG (42,4 mm <sup>2</sup> )
1/0 AWG	1323G2-BK	Main Contact PP – 1/0 AWG (53,5 mm <sup>2</sup> )

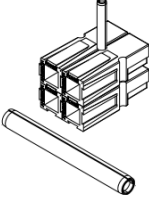
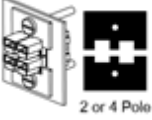
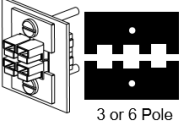
<b>Accessories</b>		
<b>Picture</b>	<b>Ordering code</b>	<b>Description</b>
	5919-BK 5920-BK 5921-BK	Reducing Bushing APP 2 AWG - 4 AWG (33,6 - 21,2 mm <sup>2</sup> ) Reducing Bushing APP 2 AWG - 6 AWG (33,6 - 13,3 mm <sup>2</sup> ) Reducing Bushing APP 2 AWG - 8 AWG (33,6 - 8,4 mm <sup>2</sup> )
	110G19 110G20	PP75/120 – Retaining Pin – 1 Block High PP120 – Retaining Pin – 2 Block High
 2 or 4 Pole	1464G1	PP120 – 2&4P Mounting Clamp – Set
 3 or 6 Pole	1464G2	PP120 – 3&6P Mounting Clamp – Set

## PP180

### Standard housings

Color	Ordering code	Description
Red	1381G3-BK	Housing PP180 – Red
Green	1381G4-BK	Housing PP180 – Green
Black	1381G1-BK	Housing PP180 – Black
White	1381G2-BK	Housing PP180 – White
Blue	1381-BK	Housing PP180 – Blue

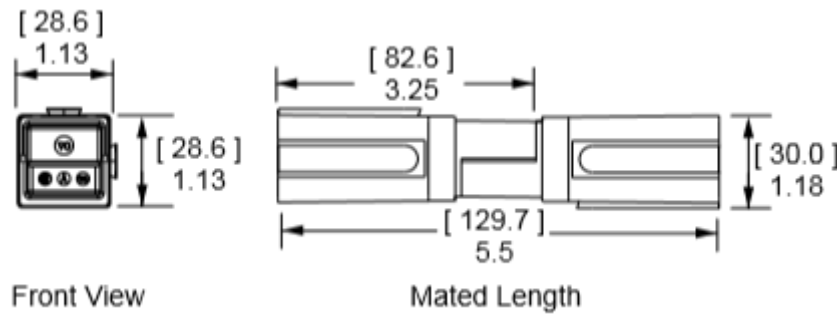

### Silver plated wire contacts

Section	Ordering code	Description
6 AWG	1348-BK	Main Contact PP180 / SB175 – 6 AWG (13,3 mm <sup>2</sup> )
4 AWG	1384-BK	Main Contact PP180 / SB175 – 4 AWG (21,2 mm <sup>2</sup> )
2 AWG	1383-BK	Main Contact PP180 / SB175 – 2 AWG (33,6 mm <sup>2</sup> )
1 AWG	1347-BK	Main Contact PP180 / SB175 – 1 AWG (42,4 mm <sup>2</sup> )
1/0 AWG	1382-BK	Main Contact PP180 / SB175 – 1/0 AWG (53,5 mm <sup>2</sup> )
2/0 AWG	1328G1-BK	Main Contact PP180 – 2/0 AWG (67,4 mm <sup>2</sup> )
3/0 AWG	1328G2-BK	Main Contact PP180 – 3/0 AWG (85,0 mm <sup>2</sup> )

### Accessories

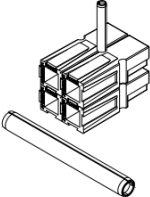
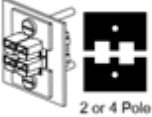
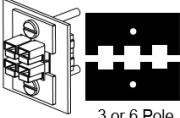
Picture	Ordering code	Description
	5648-BK 5663-BK 5690-BK 5687-BK	Reducing Bushing APP AWG 1/0 - 10 AWG (53,5 - 5,3 mm <sup>2</sup> ) Reducing Bushing APP AWG 1/0 - 6 AWG (53,5 - 13,3 mm <sup>2</sup> ) Reducing Bushing APP AWG 1/0 - 2 AWG (53,5 - 33,62 mm <sup>2</sup> ) Reducing Bushing APP AWG 1/0 - 1 AWG (53,5 - 42,4 mm <sup>2</sup> )
	110G18 110G20	PP180 – Retaining Pin – 1 Block High PP120/180 – Retaining Pin – 2 Block High
 2 or 4 Pole	1465G1	PP180 – 2&4P Mounting Clamp – Set
 3 or 6 Pole	1465G2	PP180 – 3&6P Mounting Clamp – Set