REMA CONNECTORS



REMA Group, with locations in Germany, China and the USA, is one of the international technological leaders in the field of high-current contact systems. They develop and produce connector systems for charging electric vehicles, high-current connection materials and crimping tools as well as technologically sophisticated operator interfaces with integrated electronics. The development of the company was always supported by intensive research and development work. Through targeted knowledge transfer, new markets are continually explored and new, innovative products developed.

EURO-DIN Connectors

REMA is the leading supplier of DIN-style (DIN standard 43589) quick disconnect power connectors. These quick disconnect power connectors are used in a variety of applications, including:

Materials Handling - Aerial Lift - Sweeper/Scrubber - Utility Vehicles - Motive Power - Battery Chargers.

In order to withstand the frequent use in these rough environments it is imperative that the construction of these connectors be extremely robust. The REMA brand DIN-style connectors exceed the requirement of the DIN Standard 43589 for both mechanical and electrical durability.

To meet the demands of newer high-current applications, including “fast charging”, REMA has developed a larger capacity DIN 640 A connector.

Contacts are made from E-Cu copper optimized for crimp connection. Crimp tooling and dies are contained in this catalogue. Only the use of REMA crimp equipment results in full warranty.

Features of the REMA DIN-style connector include:

- Housing constructed of glass fiber reinforced composite material for extreme durability and resistance battery acid
- REMA engineered contacts made of high grade electrolyte copper and silver plated for corrosion protection
- UL 1977 certified component
- Meets or exceeds the following industry standards: DIN 43589, EN 1175-1, IEC 20989, UL1977
- In compliance with machinery directive 2006/42 EG and therefore with „CE“ Marking
- Accepts REMA DIN-Style Connector Options including coding/locking pins, air supply, auxiliary contacts and handles
- Small number of parts
- Easy, intuitive assembly



DIN 80 

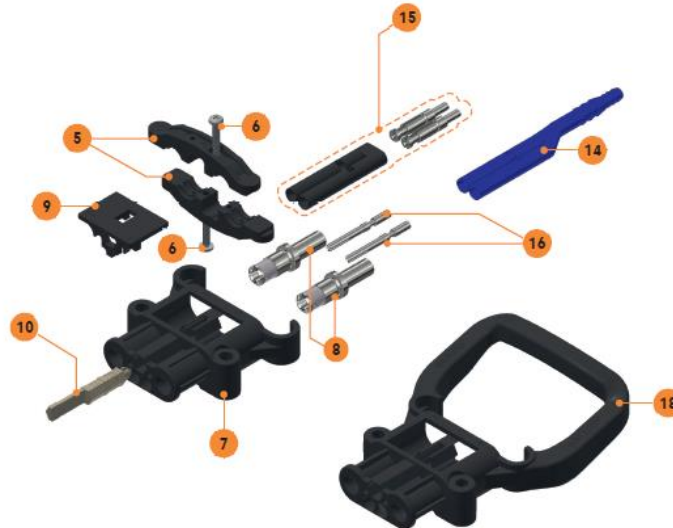

Female connector

Item	Ordering code	Description
5(2x)/6/7/ 8/9/10*	95306-00 95309-00 95309-10	REMA DIN 80 Female – 16 mm ² REMA DIN 80 Female – 25 mm ² REMA DIN 80 Female – 35 mm ²
5/6/7/9	95425-01	Housing REMA DIN 80 Female – incl. Cable Clamp
8	75317-00 75318-00 75319-00	Main Contact REMA DIN 80 Female – 16 mm ² Main Contact REMA DIN 80 Female – 25 mm ² Main Contact REMA DIN 80 Female – 35 mm ²
10	75435-00 75438-00	REMA DIN 80 Coding Pin – Grey REMA DIN 80 Coding Pin – Green
14	75070-42	Air Adapter REMA DIN 80 Female
15	75289-00	Pilot Contacts (2 pcs.+ adapter) REMA DIN 80 Female
16	75240-02	Auxiliary Contact REMA DIN 80 – Female
5(2x)/6/8/ 9/10/18*	95306-01 95342-01 95309-01	REMA DIN 80 Female – 16 mm ² – with Molded Handle REMA DIN 80 Female – 25 mm ² – with Molded Handle REMA DIN 80 Female – 35 mm ² – with Molded Handle
18	95425-05	Housing REMA DIN 80 Female with Molded Handle and Cable Clamp

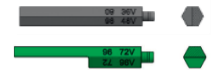

*Standard with grey coding pin

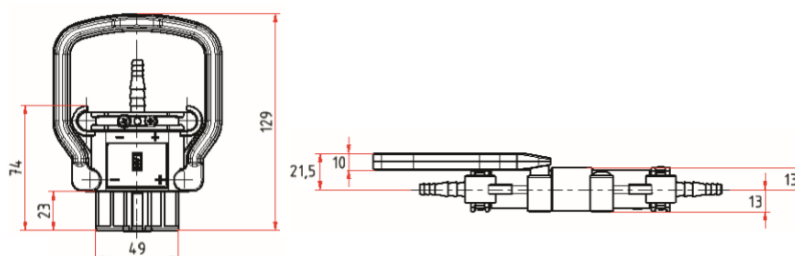

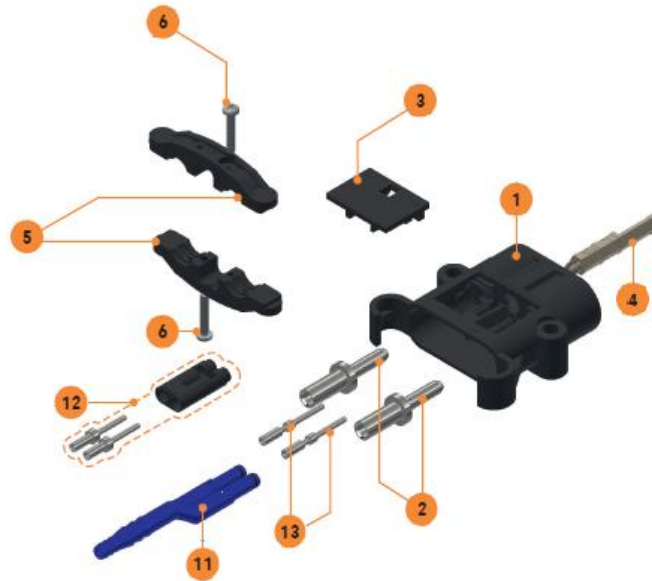

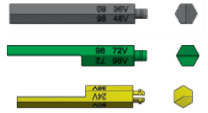

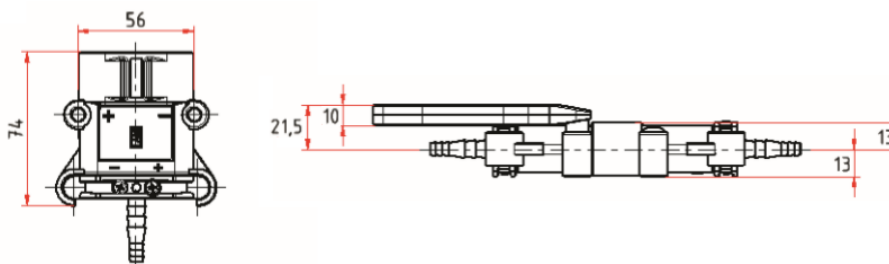

Male connector			
Item	Ordering code	Description	
1/2/3/4/ 5(2x)/6*	95198-10	REMA DIN 80 Male – 10 mm ²	
	95199-00	REMA DIN 80 Male – 16 mm ²	
	95198-00	REMA DIN 80 Male – 25 mm ²	
	95199-10	REMA DIN 80 Male – 35 mm ²	
1/3/5(2x)/6	95427-01	Housing REMA DIN 80 Male – incl. Cable Clamp	
2	75314-10	Main Contact REMA DIN 80 Male – 10 mm ²	
	75314-00	Main Contact REMA DIN 80 Male – 16 mm ²	
	75315-00	Main Contact REMA DIN 80 Male – 25 mm ²	
	75316-00	Main Contact REMA DIN 80 Male – 35 mm ²	
4	75435-00	REMA DIN 80 Coding Pin – Grey	
	75438-00	REMA DIN 80 Coding Pin – Green	
	75436-00	REMA DIN 80 Coding Pin – Yellow	
11	75070-43	Air Adapter REMA DIN 80 Male	
12	75243-00	Pilot Contacts (2 pcs.+ adapter) REMA DIN 80 Male	
13	75070-02	Auxiliary Contact REMA DIN 80/160 Male	

*Standard with grey coding pin



Accessories

Picture	Ordering code	Description
	79811-00 79812-00 75327-01	Reducing Bushing REMA 16 mm ² - 10 mm ² Reducing Bushing REMA 25 mm ² - 10 mm ² Reducing Bushing REMA 35 mm ² - 10 mm ²
	95244-01 95244-00 75229-00	Handle REMA DIN 80 – with screws M6x30 – Grey Snap-on Handle REMA DIN 80 – Standard (Click-on) Handle REMA DIN 80 – Red
	LV80 H1/S	Handle SCHALTBAU DIN 80 with 2 screws – Black
	80283-10	Locking Plate – REMA DIN 80

DIN 160 



Female connector		
Item	Ordering code	Description
5(2x)/6/7/ 8/9/10*	95001-08 95007-08 95012-08 95017-08 95022-08	REMA DIN 160 Female – 16 mm ² REMA DIN 160 Female – 25 mm ² REMA DIN 160 Female – 35 mm ² REMA DIN 160 Female – 50 mm ² REMA DIN 160 Female – 70 mm ²
5/6/7/9	95026-01	Housing REMA DIN 160 Female- incl. Cable Clamp
8	75021-01 75022-01 75023-01 75024-01 75024-05	Main Contact REMA DIN 160 Female – 16 mm ² Main Contact REMA DIN 160 Female – 25 mm ² Main Contact REMA DIN 160 Female – 35 mm ² Main Contact REMA DIN 160 Female – 50 mm ² Main Contact REMA DIN 160 Female – 70 mm ²
10	75057-01 75233-01 75057-95	REMA DIN 160/320 Coding Pin – Grey REMA DIN 160/320 Coding Pin – Green REMA DIN 160/320 Coding Pin Female – Blue
14	75070-12	Air Adapter REMA DIN 160 Female
15	75068-03	Pilot Contacts (2 pcs.+ adapter) REMA DIN 160 Female
16	77640-00	Auxiliary Contact REMA DIN 160 – Female
5(2x)/6/8/ 9/10/18*	95001-01 95007-01 95012-01 95017-01 95017-05	REMA DIN 160 Female – 16 mm ² – with Molded Handle REMA DIN 160 Female – 25 mm ² – with Molded Handle REMA DIN 160 Female – 35 mm ² – with Molded Handle REMA DIN 160 Female – 50 mm ² – with Molded Handle REMA DIN 160 Female – 70 mm ² – with Molded Handle
18	95026-04	Housing REMA DIN 160 Female with Molded Handle and Cable Clamp

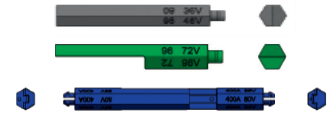

*Standard with grey coding pin

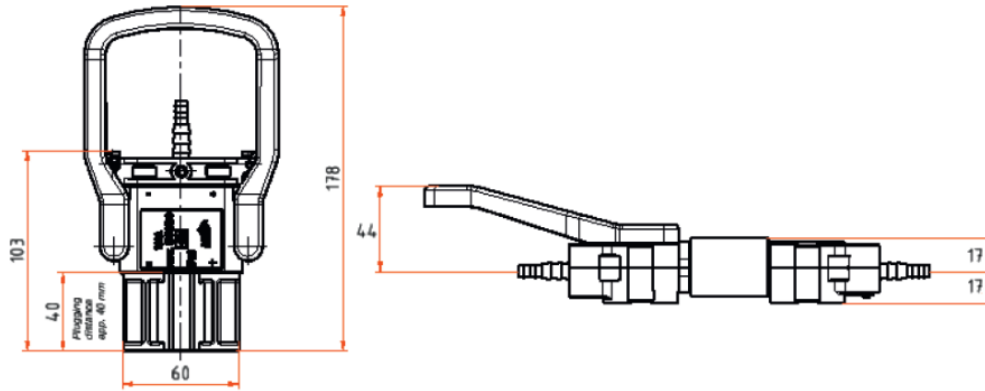

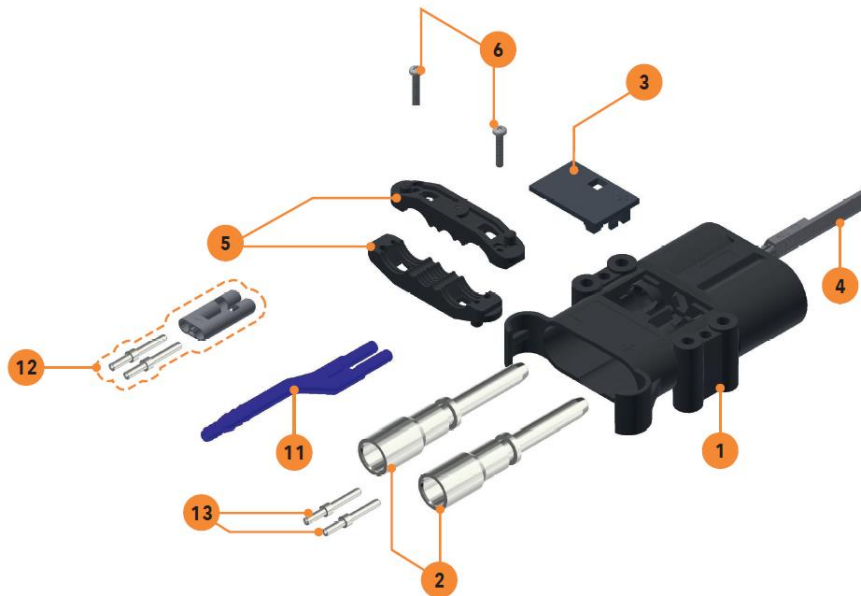



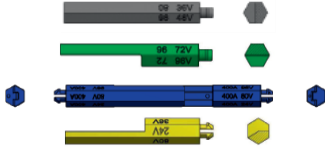



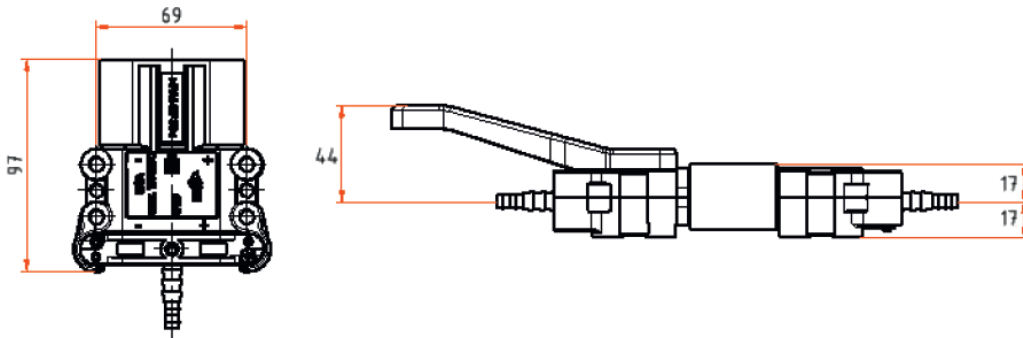

Male connector

Item	Ordering code	Description	
1/2/3/4/ 5(2x)/6*	95029-01 95034-01 95039-01 95044-01 95044-04	REMA DIN 160 Male – 16 mm ² REMA DIN 160 Male – 25 mm ² REMA DIN 160 Male – 35 mm ² REMA DIN 160 Male – 50 mm ² REMA DIN 160 Male – 70 mm ²	
1/3/4/5(2x)/6	95053-01	Housing REMA DIN 160 Male – incl. Cable Clamp	
2	75048-10 75048-01 75049-01 75050-01 75051-01 75051-05	Main Contact REMA DIN 160 Male – 10 mm ² Main Contact REMA DIN 160 Male – 16 mm ² Main Contact REMA DIN 160 Male – 25 mm ² Main Contact REMA DIN 160 Male – 35 mm ² Main Contact REMA DIN 160 Male – 50 mm ² Main Contact REMA DIN 160 Male – 70 mm ²	
4	75057-01 75233-01 75057-90 75231-01	REMA DIN 160/320 Coding Pin – Grey REMA DIN 160/320 Coding Pin – Green REMA DIN 160/320 Coding Pin Male – Blue REMA DIN 160/320 Coding Pin – Yellow	
11	75070-13	Air Adapter REMA DIN 160 Male	
12	75070-03	Pilot Contacts (2 pcs.+ adapter) REMA DIN 160 Male	
13	75070-02	Auxiliary Contact REMA DIN 80/160 Male	

*Standard with grey coding pin



Accessories

Picture	Ordering code	Description
	79811-00 79812-00 75327-01	Reducing Bushing REMA 16 mm ² - 10 mm ² Reducing Bushing REMA 25 mm ² - 10 mm ² Reducing Bushing REMA 35 mm ² - 10 mm ²
	95066-65 95066-68 75066-66	Screwed Handle DIN 160 – Standard with 4 screws Handle REMA DIN 160/320 (8 screws) Handle REMA DIN 160 – Red (4 screws)
	95239-07	Screwed Flat Handle DIN 160 A – 2 bolts 43 mm, security nuts
	EHDL-EN	Handle DIN 160-320 A – Long Steel – PVC
	EHDL-TOY	Handle DIN 160-320 – Steel – with PVC-coating
	LV160/320 H1/S	Handle Schaltbau LV/LB-L 160/320 A with screws – Black
	80283-11	Locking Plate – REMA DIN 160

DIN 320



Female connector			
Item	Ordering code	Description	
5(2x)/6/7/ 8/9/10*	95601-01 95605-01 95610-01	REMA DIN 320 Female – 50 mm ² REMA DIN 320 Female – 70 mm ² REMA DIN 320 Female – 95 mm ²	
5/6/7/9	95700-01	Housing REMA DIN 320 Female – incl. Cable Clamp	
8	75660-01 75665-01 75670-01	Main Contact REMA DIN 320 Female – 50 mm ² Main Contact REMA DIN 320 Female – 70 mm ² Main Contact REMA DIN 320 Female – 95 mm ²	
10	75057-01 75233-01 75057-95	REMA DIN 160/320 Coding Pin – Grey REMA DIN 160/320 Coding Pin – Green REMA DIN 160/320 Coding Pin Female – Blue	
14	75070-32	Air Adapter REMA DIN 320/640 Female	
15	75591-00	Pilot Contacts (2 pcs.+ adapter) REMA DIN 320/640 Female	
16	75590-02	Auxiliary Contact REMA DIN 320/640 Female	

*Standard with grey coding pin

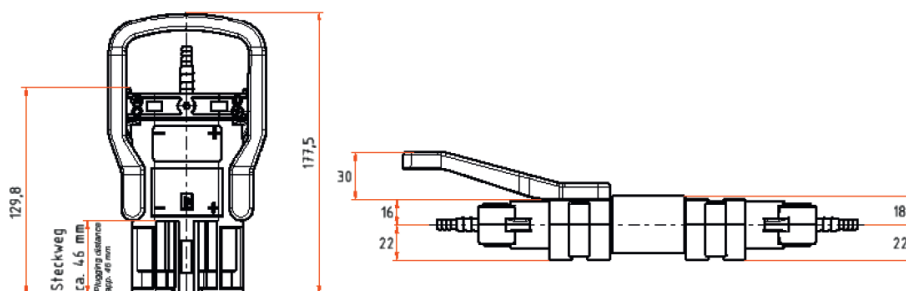

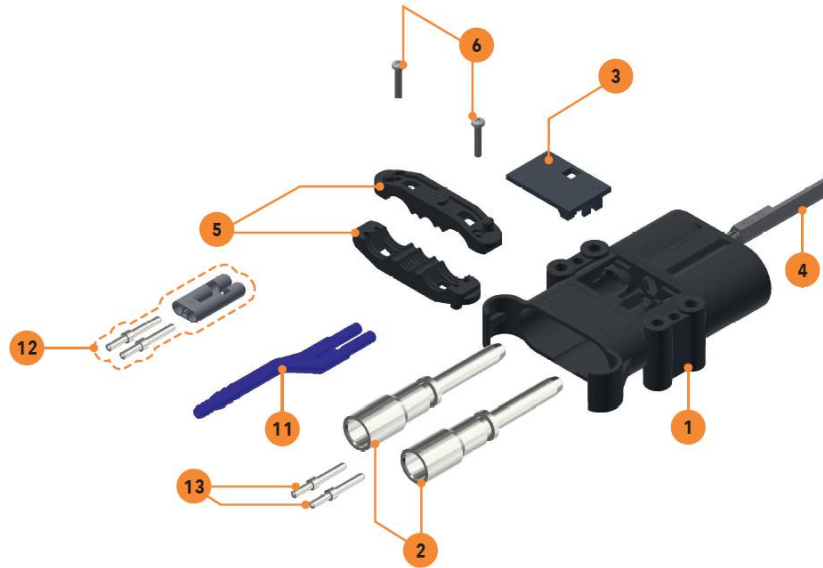

Male connector



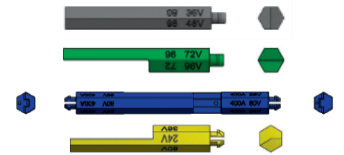

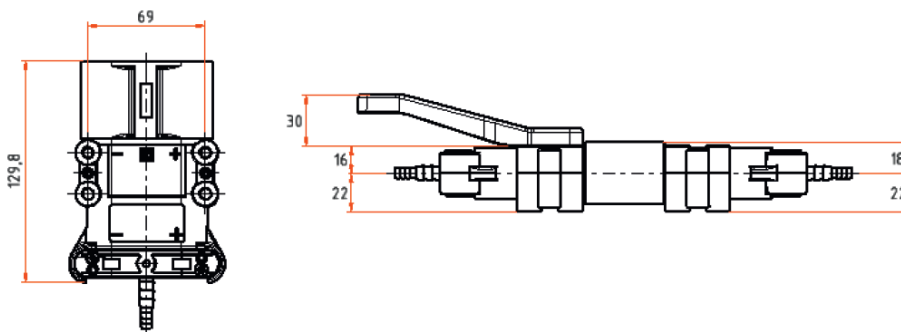

Item	Ordering code	Description
1/2/3/4/ 5(2x)/6*	95500-01 95505-01 95510-01	REMA DIN 320 Male – 50 mm ² REMA DIN 320 Male – 70 mm ² REMA DIN 320 Male – 95 mm ²
1/3/5(2x)/6	95600-01	Housing REMA DIN 320 Male – incl. Cable Clamp
2	75560-01 75565-01 75570-01	Main Contact REMA DIN 320 Male – 50 mm ² Main Contact REMA DIN 320 Male – 70 mm ² Main Contact REMA DIN 320 Male – 95 mm ²
4	75057-01 75233-01 75057-90 75231-01	REMA DIN 160/320 Coding Pin – Grey REMA DIN 160/320 Coding Pin – Green REMA DIN 160/320 Coding Pin Male – Blue REMA DIN 160/320 Coding Pin – Yellow
11	75070-33	Air Adapter REMA DIN 320/640 Male
12	75596-00	Pilot Contacts (2 pcs.+ adapter) REMA DIN 320/640 Male
13	75595-01	Auxiliary Contact REMA DIN 320/640 Male



*Standard with grey coding pin



Accessories

Picture	Ordering code	Description
	79817-00 79816-00 77605-00	Reducing Bushing REMA 50 mm ² - 35 mm ² Reducing Bushing REMA 50 mm ² - 25 mm ² Reducing Bushing REMA 50 mm ² - 16 mm ²
	95066-67 95066-68 75066-68	Screwed Handle REMA DIN 320 – Standard with 4 screws Handle REMA DIN 160/320 (8 screws) Handle REMA DIN 320 – Red (4 screws)
	95239-05	Screwed Flat Handle REMA DIN 320 - 2 bolts 50 mm, security nuts
	EHDL-EN	Handle DIN 160-320 A – Long Steel – PVC
	EHDL-TOY	Handle DIN 160-320 – Steel with PVC-coating
	LV160/320 H1/S	Handle Schaltbau LV/LB-L 160/320 A with screws – Black
	80283-12	Locking Plate – REMA DIN 320

DIN 640

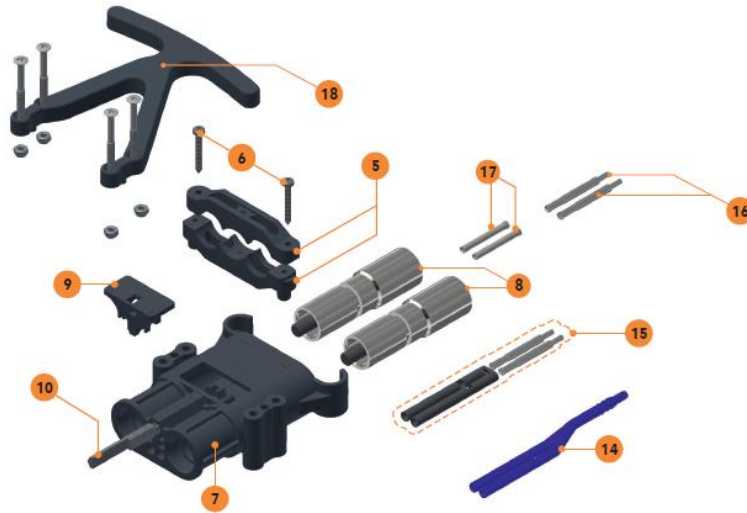

Female connector		
Item	Ordering code	Description
5(2x)/6/7/ 8/9/10*	95950-30 95950-20 95950-10 95950-00	REMA DIN 640 Female – 70 mm ² REMA DIN 640 Female – 95 mm ² REMA DIN 640 Female – 120 mm ² REMA DIN 640 Female – 240 mm ²
10	75057-01 75233-01 75057-95	REMA DIN 160/320 Coding Pin – Grey REMA DIN 160/320 Coding Pin – Green REMA DIN 160/320 Coding Pin Female – Blue
14	75070-32	Air Adapter REMA DIN 320/640 Female
15	75591-00	Pilot Contacts (2 pcs.+ adapter) REMA DIN 320/640 Female
16	75590-02	Auxiliary Contact REMA DIN 320/640 Female
17	M93320-74	Auxiliary Contact REMA MRC 320 Female – 2 pieces

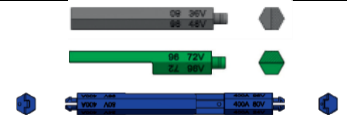

*Standard with grey coding pin

*Only available in kit with main contacts

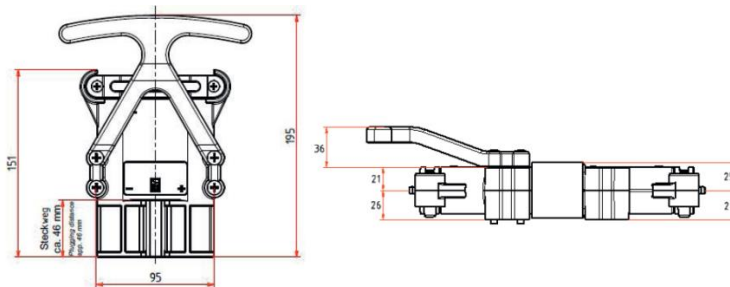

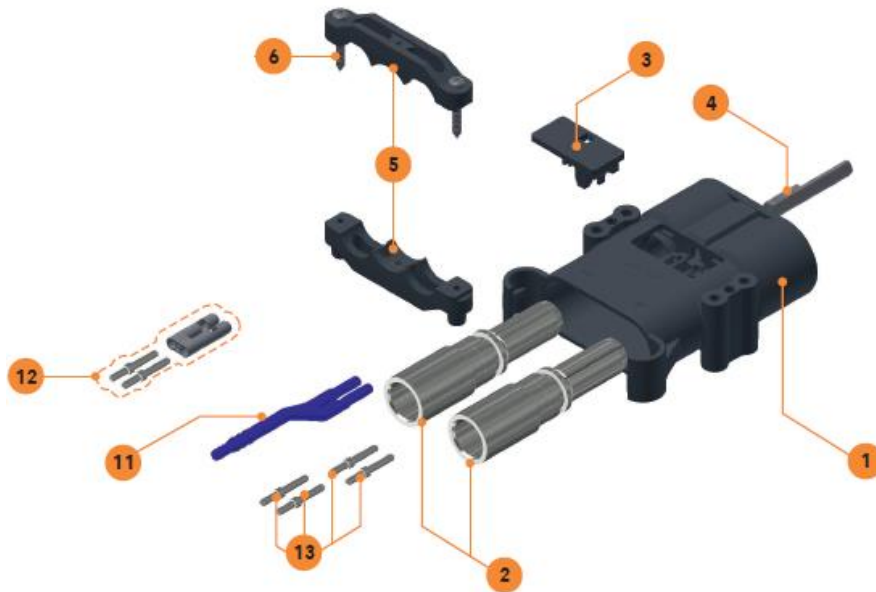

Male connector		
Item	Ordering code	Description
1/2/3/4/ 5(2x)/6*	95850-30	REMA DIN 640 Male – 70 mm ²
	95850-20	REMA DIN 640 Male – 95 mm ²
	95850-10	REMA DIN 640 Male – 120 mm ²
	95850-00	REMA DIN 640 Male – 240 mm ²
4	75057-01	REMA DIN 160/320 Coding Pin – Grey
	75233-01	REMA DIN 160/320 Coding Pin – Green
	75057-90	REMA DIN 160/320 Coding Pin Male – Blue
	75231-01	REMA DIN 160/320 Coding Pin – Yellow
11	75070-33	Air Adapter REMA DIN 320/640 Male
12	75596-00	Pilot Contacts (2 pcs.+ adapter) REMA DIN 320/640 Male
13	75595-01	Auxiliary Contact REMA DIN 320/640 Male

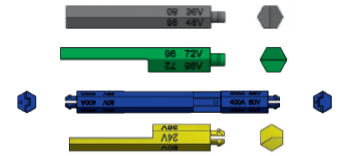

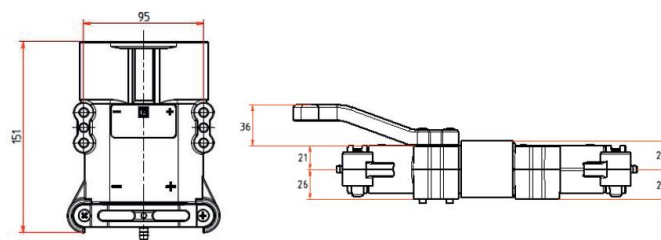

*Standard with grey coding pin

*Only available in kit with main contacts



Accessories

Picture	Ordering code	Description
	95800-11	Handle REMA DIN 640 (4 screws)
	EHDL-MET-TOY-640-SCR	Screwed Metal Handle DIN 640 with PVC-coating - L: 135 mm + 4 screws