

RAVIOLI CONNECTORS



Born in 1926, after more than 90 years of successful activity, Ravioli S.p.A. is a brilliant, dynamic and worldwide renowned manufacturer of mechanical and electromechanical devices for industry. Founded and based in Milan, Northern Italy, Ravioli S.p.A. is very well known all over the world, thanks to the development of a solid and reliable network of dealers and partners, started more than 30 years ago. Designing, projecting, testing and assembling in-house all the products, Ravioli maintains the production strongly rooted in the territory, guaranteeing the high quality standards of Made in Italy, accordance to EU Norms and Directives, user-friendly design, customer care and technical assistance as well as innovative and updated solutions for each product.

Europa Series

Including the versions 80 A, 160 A, 320 A, this range is in accordance with the current Norms DIN VDE 0623-589, defining unified distances between centres and representing the evolution of the previous DIN Norms.

The series includes 2 versions:

- Shock resistant housing – suitable for all applications requiring high resistance against shocks;
- Acid- proof polymer housing – suitable for applications needing elevated resistance against acid.

The improved version 320A is also available for the cabling of a 95mm² diameter cable, feature that allows to further enlarge the range of use of the products on different applications.

Europe Series 80-160-320 A



DIN 80



Female connector		
Item	Ordering code	Description
5/6/7/8/9/10	EPBC80AR1 EPBC80ST1	RAVIOLI DIN 80 Female – 16/25 mm ² – Acid Proof – Grey Coding Pin RAVIOLI DIN 80 Female – 16/25 mm ² – Shock Resistant – Grey Coding Pin
2	EXP80PRAR EXP80PRST	Pilot Contact RAVIOLI DIN 80 Female – 2 pieces – Acid Resistant Pilot Contact RAVIOLI DIN 80 Female – 2 pieces – Not Acid Resistant
3	EXP80SEC	Auxiliary Contact RAVIOLI 80 Female – 2 pieces
4	EAIRTUBE80P	Air Adapter RAVIOLI DIN 80 Female
7	E34404 E34434 E34435	Coding Pin RAVIOLI DIN 80 – Grey Coding Pin RAVIOLI DIN 80 – Green Coding Pin RAVIOLI DIN 80 – Yellow

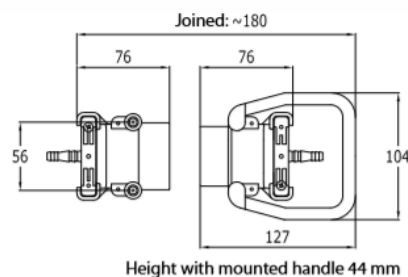
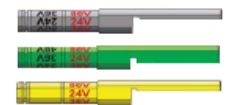

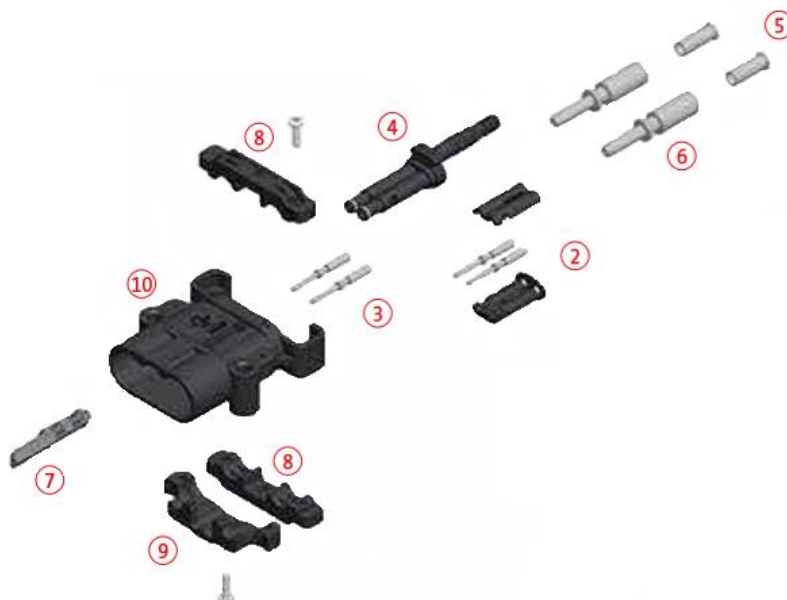

Male connector

Item	Ordering code	Description
5/6/7/8/9/10	ESBC80AR1 ESBC80ST1	RAVIOLI DIN 80 Male – 16/25 mm ² – Acid Proof – Grey Coding Pin RAVIOLI DIN 80 Male – 16/25 mm ² – Shock Resistant – Grey Coding Pin
2	EXS80PRAR EXS80PRST	Pilot Contact RAVIOLI DIN 80 Male – 2 pieces – Acid Resistant Pilot Contact RAVIOLI DIN 80 Male – 2 pieces – Not Acid Resistant
3	EXS80SEC	Auxiliary Contact RAVIOLI 80 Male – 2 pieces
4	EAIRTUBE80S	Air Adapter RAVIOLI DIN 80 Male
7	E34404 E34434 E34435	Coding Pin RAVIOLI DIN 80 – Grey Coding Pin RAVIOLI DIN 80 – Green Coding Pin RAVIOLI DIN 80 – Yellow

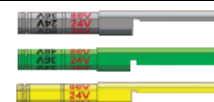

Accessories

Picture	Ordering code	Description
	EMAN80AR EMAN80ARRED EMAN80ST	Handle RAVIOLI DIN 80 – Acid Proof Handle RAVIOLI DIN 80 – Acid Proof – Red Handle RAVIOLI DIN 80 – Not Acid Proof

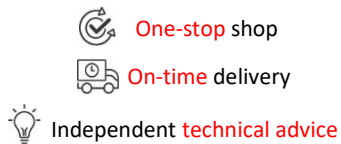

Ordering code

XXXX 80 XX X

Gender: _____
ESBC = Plug
EPBC = Socket
EKPM = Socket + handle

Range: _____
80

Version: _____
AR = Acid-Proof
ST = Shock Resistant

Color Coding Pin: _____
1 = Grey
2 = Yellow
3 = Green

DIN 160



Female connector

Item	Ordering code	Description
5/6/7/8/ 9/10	EPBC160AR1	RAVIOLI DIN 160 Female – 35/50 mm ² – Acid Proof – Grey Coding Pin
	EPBC160AR1-25	RAVIOLI DIN 160 Female – 25/50 mm ² – Acid Proof – Grey Coding Pin
	EPBC160ST1	RAVIOLI DIN 160 Female – 35/50 mm ² – Shock Resistant – Grey Coding Pin
	EPBC160ST1-25	RAVIOLI DIN 160 Female – 25/50 mm ² – Shock Resistant – Grey Coding Pin
2	EXP160320PRAR	Pilot Contact RAVIOLI DIN 160/320 Female – 2 pieces – Acid Resistant
	EXP160320PRST	Pilot Contact RAVIOLI DIN 160/320 Female – 2 pieces – Not Acid Resistant
3	EXP160SEC	Auxiliary Contact RAVIOLI 160 Female – 2 pieces
4	EAIRTUBE160P	Air Adapter RAVIOLI DIN 160 Female
7	E29304	Coding Pin RAVIOLI DIN 160/320 – Grey
	E29366	Coding Pin RAVIOLI DIN 160/320 – Green
	E29367	Coding Pin RAVIOLI DIN 160/320 – Yellow

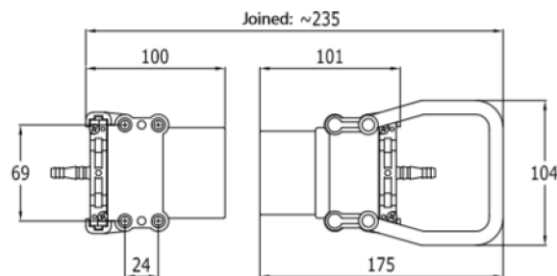
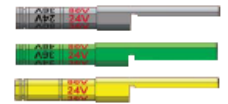

Height with mounted standard handle: 57 mm.
Height with mounted flat handle: 40,5 mm.

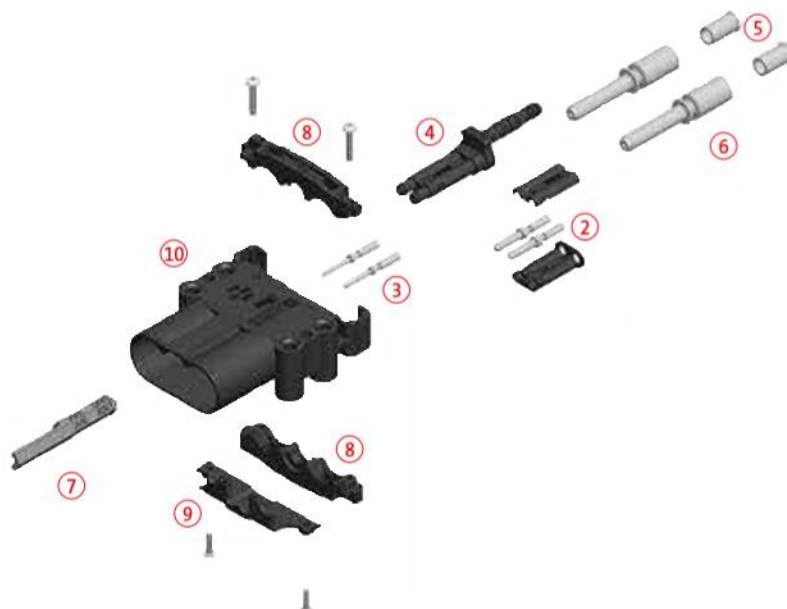

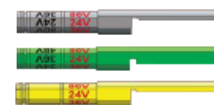

Male connector

Item	Ordering code	Description
5/6/7/8/ 9/10	ESBC160AR1	RAVIOLI DIN 160 Male – 35/50 mm ² – Acid Proof – Grey Coding Pin
	ESBC160AR1-25	RAVIOLI DIN 160 Male – 25/50 mm ² – Acid Proof – Grey Coding Pin
	ESBC160ST1	RAVIOLI DIN 160 Male – 35/50 mm ² – Shock Resistant – Grey Coding Pin
	ESBC160ST1-25	RAVIOLI DIN 160 Male – 25/50 mm ² – Shock Resistant – Grey Coding Pin
2	EXS160320PRAR	Pilot Contact RAVIOLI DIN 160/320 Male – 2 pieces – Acid Resistant
	EXS160320PRST	Pilot Contact RAVIOLI DIN 160/320 Male – 2 pieces – Not Acid Resistant
3	EXS160SEC	Auxiliary Contact Ravioli 160 Male – 2 pieces
4	EAIRTUBE160S	Air Adapter RAVIOLI DIN 160 Male
7	E29304	Coding Pin RAVIOLI DIN 160/320 – Grey
	E29366	Coding Pin RAVIOLI DIN 160/320 – Green
	E29367	Coding Pin RAVIOLI DIN 160/320 – Yellow



Accessories

Picture	Ordering code	Description
	ERID50-25	Reducing Bushing RAVIOLI 50 mm ² - 25 mm ²
	EM160320ST	Handle RAVIOLI DIN 160/320 – Euro
	EM160320AR	Handle RAVIOLI DIN 160/320 – Acid Proof
	EM160320ARRED	Handle RAVIOLI DIN 160/320 – Acid Proof – Red
	EM160320STP	Flat Handle RAVIOLI DIN 160/320

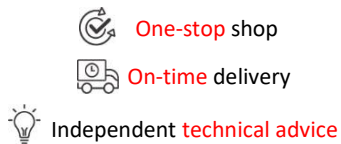

Ordering code

XXXX 160 XX X

Gender: _____

ESBC = Plug

EPBC = Socket

EKPM = Socket + handle

Range: _____

160

Version: _____

AR = Acid-Proof

ST = Shock Resistant

Color Coding Pin: _____

1 = Grey

2 = Yellow

3 = Green

DIN 320

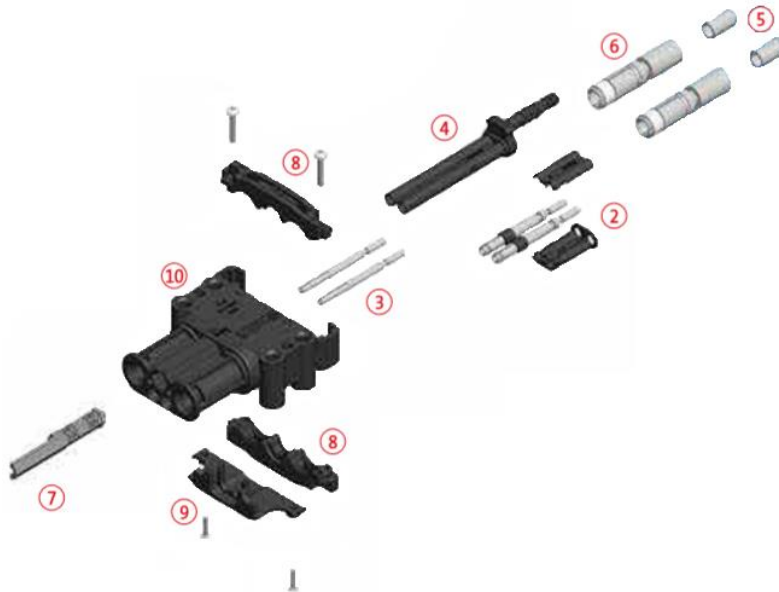

Female connector

Item	Ordering code	Description
5/6/7/8/ 9/10	EPBC320AR1	RAVIOLI DIN 320 Female – 50/70 mm ² – Acid Proof – Grey Coding Pin
	EPBC320ST1	RAVIOLI DIN 320 Female – 50/70 mm ² – Shock Resistant – Grey Coding Pin
	EPBC320AR1-95	RAVIOLI DIN 320 Female – 95 mm ² – Acid Proof – Grey Coding Pin
	EPBC320ST1-95	RAVIOLI DIN 320 Female – 95 mm ² – Shock Resistant – Grey Coding Pin
2	EXP160320PRAR	Pilot Contact RAVIOLI DIN 160/320 Female – 2 pieces – Acid Resistant
	EXP160320PRST	Pilot Contact RAVIOLI DIN 160/320 Female – 2 pieces – Not Acid Resistant
3	EXP320SEC	Auxiliary Contact RAVIOLI 320 Female – 2 pieces
4	EAIRTUBE320P	Air Adapter RAVIOLI DIN 320 Female
7	E29304	Coding Pin RAVIOLI DIN 160/320 – Grey
	E29366	Coding Pin RAVIOLI DIN 160/320 – Green
	E29367	Coding Pin RAVIOLI DIN 160/320 – Yellow

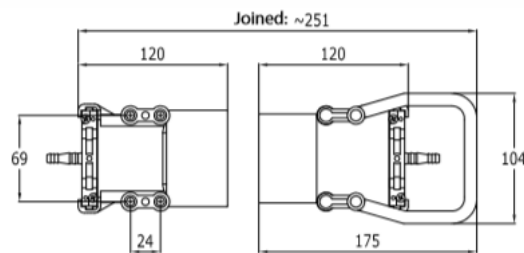
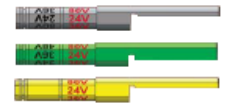

Height with mounted standard handle: 64 mm.
Height with mounted flat handle: 48 mm.

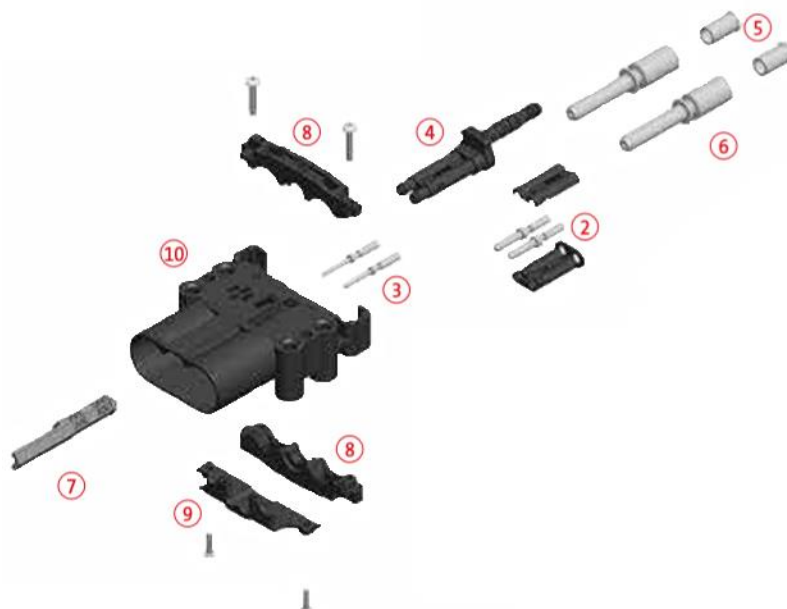

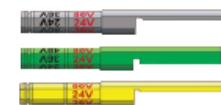

Male connector

Item	Ordering code	Description
5/6/7/8/ 9/10	ESBC320AR1	RAVIOLI DIN 320 Male – 50/70 mm ² – Acid Proof – Grey Coding Pin
	ESBC320ST1	RAVIOLI DIN 320 Male – 50/70 mm ² – Shock Resistant – Grey Coding Pin
	ESBC320AR1-95	RAVIOLI DIN 320 Male – 95 mm ² – Acid Proof – Grey Coding Pin
	ESBC320ST1-95	RAVIOLI DIN 320 Male – 95 mm ² – Shock Resistant – Grey Coding Pin
2	EXS160320PRAR	Pilot Contact RAVIOLI DIN 160/320 Male – 2 pieces – Acid Resistant
	EXS160320PRST	Pilot Contact RAVIOLI DIN 160/320 Male – 2 pieces – Not Acid Resistant
3	EXS320SEC	Auxiliary Contact RAVIOLI 320 Male – 2 pieces
4	EAIRTUBE320S	Air Adapter RAVIOLI DIN 320 Male
7	E29304	Coding Pin RAVIOLI DIN 160/320 – Grey
	E29366	Coding Pin RAVIOLI DIN 160/320 – Green
	E29367	Coding Pin RAVIOLI DIN 160/320 – Yellow



Accessories

Picture	Ordering code	Description
	ERID50-25 ERID70-35	Reducing Bushing RAVIOLI 50 mm ² - 25 mm ² Reducing Bushing RAVIOLI 70 mm ² - 35 mm ²
	EM160320ST EM160320AR EM160320ARRED	Handle RAVIOLI DIN 160/320 – Euro Handle RAVIOLI DIN 160/320 – Acid Proof Handle RAVIOLI DIN 160/320 – Acid Proof – Red
	EM160320STP	Flat Handle RAVIOLI DIN 160/320

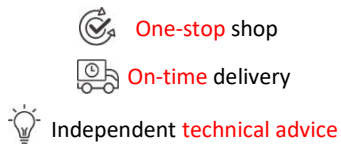

Ordering code

XXXX 320 XX X

Gender: _____
ESBC = Plug
EPBC = Socket
EKPM = Socket + handle

Range: _____
320

Version: _____
AR = Acid-Proof
ST = Shock Resistant

Color Coding Pin: _____
1 = Grey
2 = Yellow
3 = Green